

## PROFILI

(ITA)

**SISTEMI ECOLOGICI E RICICLABILI PER L'IMBALLAGGIO  
PRODOTTI IN POLIETILENE ESPANSO OTTENUTI PER ESTRUSIONE**

(ING)

**ECOLOGICAL AND RECYCLING SYSTEM FOR PACKAGING  
PRODUCTS IN POLYETHYLENE OBTAINED THROUGH EXTRUSION**

(GER)

**ÖKOLOGISCHE UND RECYCLEABRE SYSTEME FÜR DIE VERPACKUNG  
PRODUKTE AUS POLYÄTHYLEN-SCHAUM, DURCH FLIESSPRESSUNG ERZEUGT**

(FRA)

**SYSTÈMES ÉCOLOGIQUES ET RYCLABLES POUR L'EMBALLAGE  
PRODUITS EN POLYÉTHYLÈNE EXPANCÉ OBTENUS PAR EXTRUSION**

(ESP)

**SISTEMAS ECOLÓGICOS Y RECUPERABLES PARA EL EMBALAJE  
PRODUCTOS DE POLIETILENO EXPANDIDO OBTENIDOS POR EXTRUSIÓN**

## PROFILO "U"

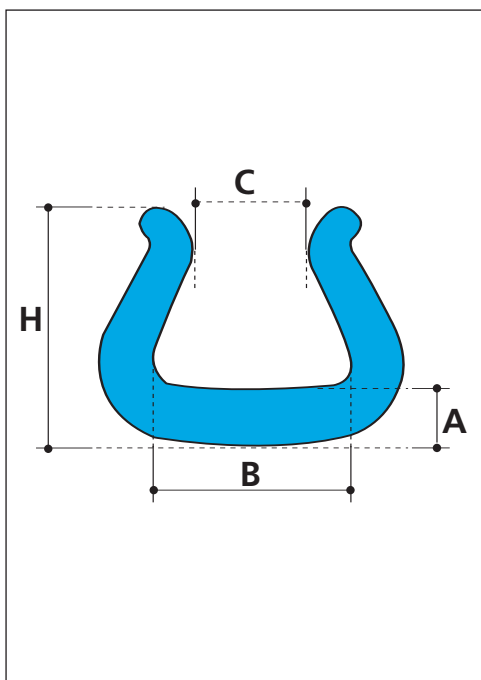
Larghezza standard	mm	Colore	Azzurro	Densità	Kg/m <sup>3</sup>	Dimensione cartone	mm
Standard length Standardlänge Longuer standard Largo estándar	2000	Colour Couleur Farbe Color	Blue Blau Bleu Azul	Density Dichte Densité Densidad	28/32	Carton size Kartongröße Dimension du carton Dimensión cartón	2100x600x450

Codice	Descrizione	A	B	C	H	x Cartone
077 PRU 0515 BN	Profilo "U" interno 5-15	8 mm ± 2	16 mm ± 3	5 mm ± 3	28 mm ± 3	520 mt
077 PRU 1020 BN	Profilo "U" interno 10-20	11 mm ± 2	20 mm ± 3	10 mm ± 3	35 mm ± 3	450 mt
077 PRU 1525 BN	Profilo "U" interno 15-25	11 mm ± 2	24 mm ± 3	13 mm ± 3	37 mm ± 3	350 mt
077 PRU 2035 BP	Profilo "U" interno 20-35 sp.8mm	8 mm ± 2	34 mm ± 3	17 mm ± 4	37 mm ± 3	330 mt
077 PRU 2035 BN	Profilo "U" interno 20-35	12 mm ± 2	35 mm ± 3	17 mm ± 4	48 mm ± 3	250 mt
077 PRU 3045 BN	Profilo "U" interno 30-45	13 mm ± 2	45 mm ± 3	25 mm ± 5	52 mm ± 3	200 mt
077 PRU 3040 BN	Profilo "U" interno 30-40 sp.20mm	20 mm ± 2	39 mm ± 3	23 mm ± 5	65 mm ± 3	130 mt
077 PRU 4060 BN	Profilo "U" interno 40-60 sp.20mm	20 mm ± 2	59 mm ± 3	32 mm ± 5	63 mm ± 3	100 mt
077 PRU 4565 BN	Profilo "U" interno 45-65	14 mm ± 2	65 mm ± 3	35 mm ± 5	64 mm ± 3	140 mt
077 PRU 6085 BN	Profilo "U" interno 60-85	14 mm ± 2	84 mm ± 3	42 mm ± 8	65 mm ± 3	120 mt
077 PRU 80100 BN	Profilo "U" interno 80-100	20 mm ± 2	96 mm ± 3	60 mm ± 10	65 mm ± 4	80 mt
077 PRU omega BN	Profilo "U" omega	11 mm ± 2	47 mm ± 3		72 mm ± 3	120 mt

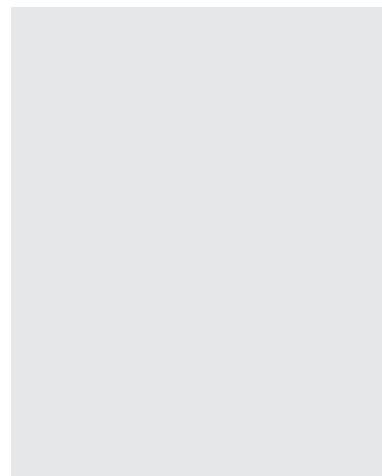
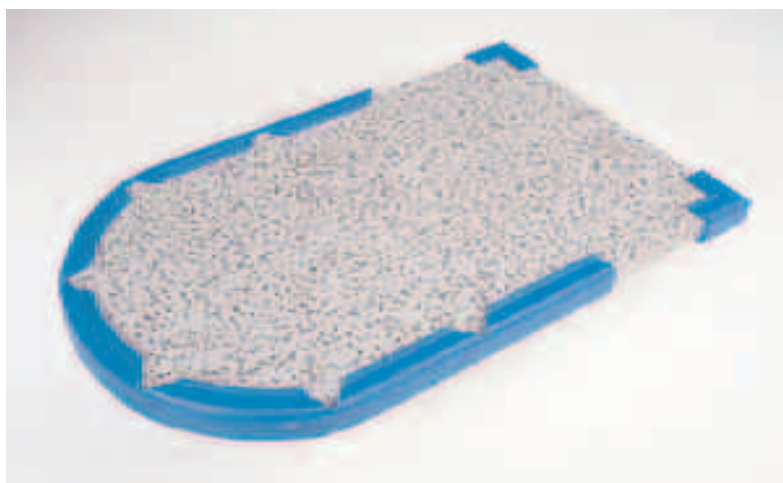

**Applicazioni**

*Fields of application*

*Verwendungsbereiche*

*Utilisations*

*Aplicaciones*

**(ITA)**

**Studiato per proteggere i bordi, si monta facilmente e si regge da solo.**

**Ideale per ripiani, tops, tavoli, marmi, ecc...**

**(ING)**

Particularly studied to protect edges, easily to fit and standing by itself.

Ideal for tops, tables, shelves, ecc...

**(GER)**

Insbesondere für den Kantenschutz geplant, ist das Aufmontieren äußerst einfach und die Profile halten von selbst. Ideal für Ablagen, Tops, Tische, Marmorartikel, usw...

**(FRA)**

Profil spécialement conçu pour la protection des bords, il peut facilement être employé pour les meubles de bureaux.

**(ESP)**

Estudiado para proteger los bordes, se monta fácilmente y se sostiene solo, ideal para estantes, encimeros, tableros de mesas, mármoles, etc.

## PROFILO "U" CON ALETTA

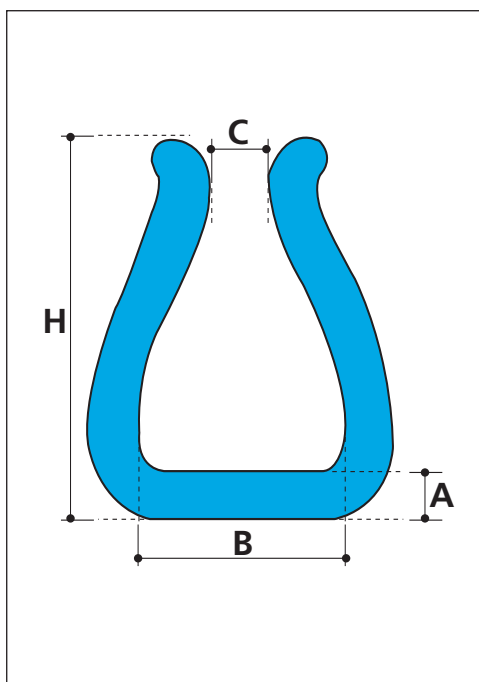
Larghezza standard	mm	Colore	Azzurro	Densità	Kg/m <sup>3</sup>	Dimensione cartone	mm
Standard length Standardlänge Longuer standard Largo estándar	2000	Colour Couleur Farbe Color	Blue Blau Bleu Azul	Density Dichte Densité Densidad	28/32	Carton size Kartongröße Dimension du carton Dimensión cartón	2100x600x450

Codice	Descrizione	A	B	C	H	x Cartone
077 PRU 2030 BN	Profilo "U" int. 28 aletta 85 sp. 28 mm	28 mm ± 2	30 mm ± 3	15 mm ± 5	90 mm ± 5	84 mt
077 PRU 3580 BN	Profilo "U" interno 35 aletta 80	15 mm ± 2	34 mm ± 3	15 mm ± 5	85 mm ± 5	130 mt
077 PRU 72120 BN	Profilo "U" interno 72 aletta 120	18 mm ± 2	77 mm ± 5	30 mm ± 15	120 mm ± 5	60 mt
077 PRU72120 DM	Profilo "U" rinforzato int. 72 aletta 140	24 mm ± 2	72 mm ± 5	30 mm ± 15	140 mm ± 5	56 mt

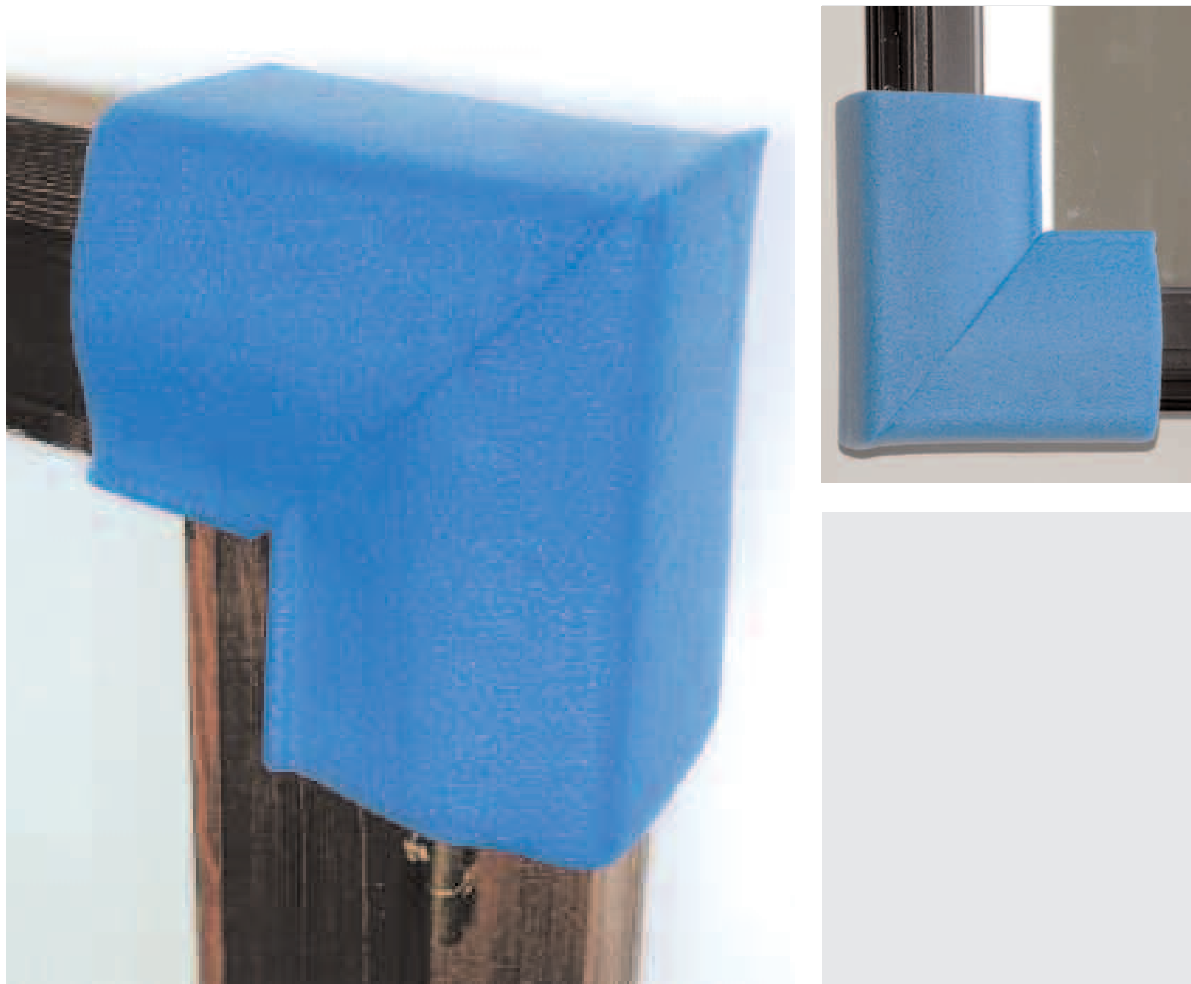

**Applicazioni**

*Fields of application  
Verwendungsbereiche  
Utilisations  
Aplicaciones*

**(ITA)**

**Studiato per proteggere i bordi, si monta facilmente e si regge da solo.**

**Ideale per ripiani, tops, tavoli, marmi, infissi, porte, ecc...**

**(ING)**

Particularly studied to protect edges, easily to fit and standing by itself.

Ideal for tops, tables, shelves, ecc...

**(GER)**

Insbesondere für den Kantenschutz geplant, ist das Aufmontieren äußerst einfach und die Profile halten von selbst. Ideal für Ablagen, Tops, Tische, Marmorartikel, usw...

**(FRA)**

Profil spécialement conçu pour la protection des bords, il peut facilement être employé pour les meubles de bureaux.

**(ESP)**

Estudiado para proteger los bordes, se monta fácilmente y se sostiene solo, ideal para estantes, encimeros, tableros de mesas, mármoles, etc.

## PROFILO "L"

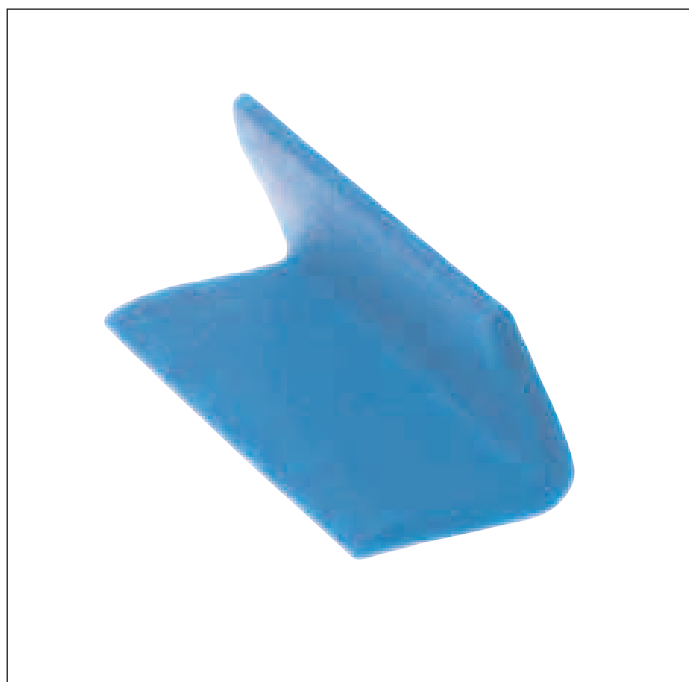
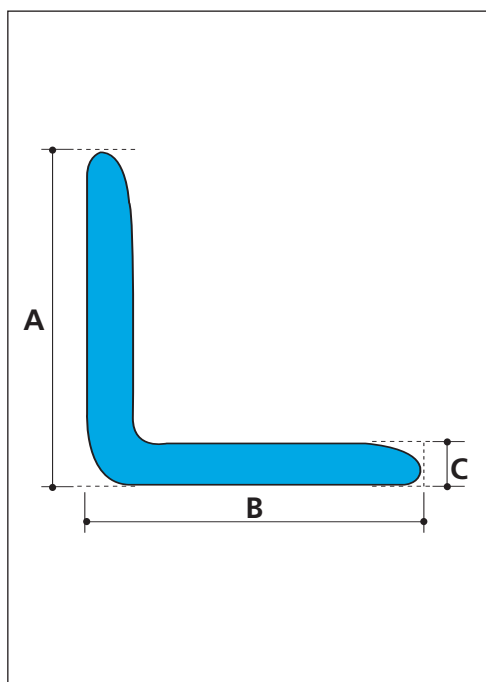
Larghezza standard	mm	Colore	Azzurro	Densità	Kg/m <sup>3</sup>	Dimensione cartone	mm
Standard length Standardlänge Longuer standard Largo estándar	2000	Colour Couleur Farbe Color	Blue Blau Bleu Azul	Density Dichte Densité Densidad	28/32	Carton size Kartongröße Dimension du carton Dimensión cartón	2100x600x450

Codice	Descrizione	A	B	C	x Cartone		
077 PRL 5050 BN	Profilo "L" sp. 6 mm	50 mm ± 2	50 mm ± 2	6 mm ± 1	550 mt		
077 PRL 7575 BN	Profilo "L" sp. 10 mm	75 mm ± 3	75 mm ± 3	10 mm ± 1	260 mt		
077 PRL 8080 BN	Profilo "L" sp. 20 mm	80 mm ± 3	80 mm ± 3	20 mm ± 2	150 mt		
077 PRL 9090 BN	Profilo "L" sp. 30 mm	90 mm ± 3	90 mm ± 3	30 mm ± 2	90 mt		



**Applicazioni**

*Fields of application  
Verwendungsbereiche  
Utilisations  
Aplicaciones*

**(ITA)**

**Protettivo di orli e spigoli è ampiamente usato nel settore del mobile e può essere impiegato anche sagomato quando si richiede la protezione dei bordi e degli angoli contemporaneamente.**

**(ING)**

To protect edges and borders is widely used in the furniture field, and it can be used also to protect corners along with edges.

**(GER)**

Zum Schutz von Ecken und Kanten finden die Profile eine häufige Verwendung im Möbelbereich und können auch geformt verwendet werden, wenn Kanten und Ecken gleichzeitig geschützt werden sollen.

**(FRA)**

Ce profil est utilisé pour la protection pour bords et angles, en particulier dans le secteur du mobilier et il peut même s'adapter pour protéger les angles et les bords en même temps.

**(ESP)**

Protector de cantos y aristas se usa ampliamente en el sector del mueble y puede emplearse también moldurado cuando se requiere la protección de los cantos y de las aristas al mismo tiempo.

## PROFILO "SISTEM"

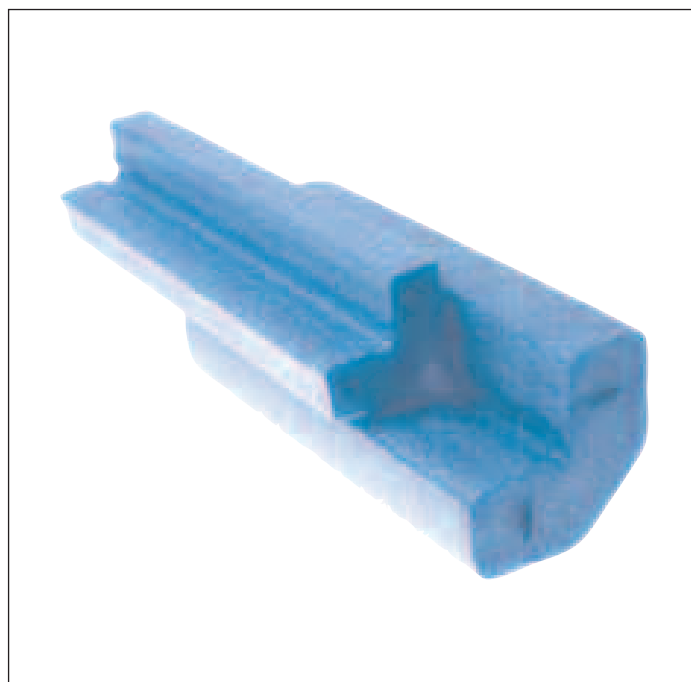
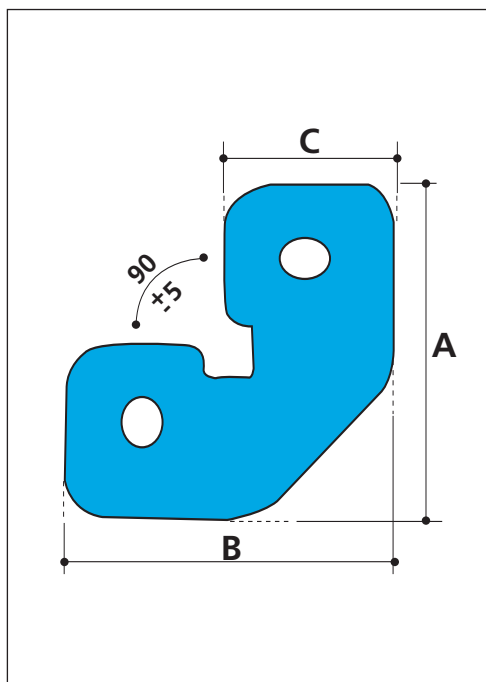

Larghezza standard	mm	Colore	Azzurro	Densità	Kg/m <sup>3</sup>	Dimensione cartone	mm
Standard length Standardlänge Longuer standard Largo estándar	2000	Colour Couleur Farbe Color	Blue Blau Bleu Azul	Density Dichte Densité Densidad	28/32	Carton size Kartongröße Dimension du carton Dimensión cartón	2100x600x450

Codice	Descrizione	A	B	C	x Cartone		
077 PRS 5050 BN	Profilo "Sistem" 50x50 sp. 20 mm	52 mm ± 2	52 mm ± 2	20 mm ± 1	230 mt		
077 PRS 6565 BN	Profilo "Sistem" 65x65 sp. 30 mm	63 mm ± 2	63 mm ± 2	30 mm ± 1	160 mt		
077 PRS 8080 BN	Profilo "Sistem" 80x80 sp. 40 mm	80 mm ± 3	80 mm ± 3	40 mm ± 2	100 mt		
077 PRS 9595 BN	Profilo "Sistem" 95x95 sp. 50 mm	95 mm ± 3	95 mm ± 3	50 mm ± 2	68 mt		

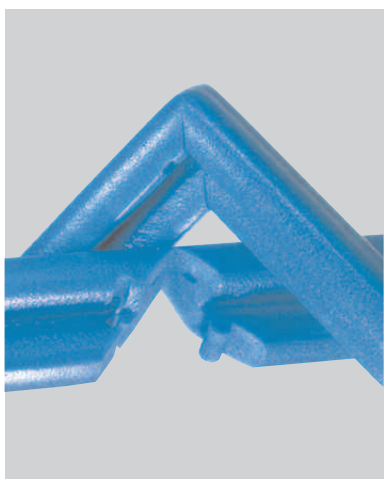
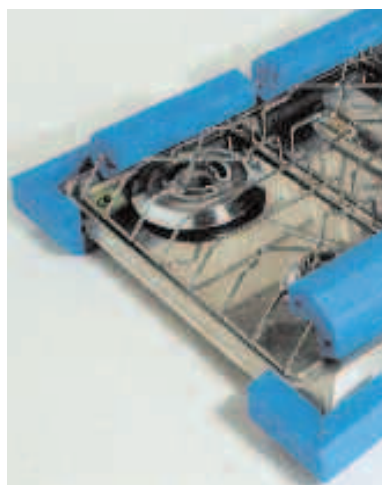

**Applicazioni**

*Fields of application  
Verwendungsbereiche  
Utilisations  
Aplicaciones*

**(ITA)**

**La sua particolare forma geometrica è ottimale nell'assorbimento degli urti e delle vibrazioni. Trova la sua utilizzazione ideale nella protezione di mobili, elettrodomestici, apparecchiature elettriche ed elettroniche.**

**(ING)**

Its particular geometric shape is very suitable to absorb crashes and vibrations. It is fit to protect furniture, electrical household appliances, electric and electronic devices.

**(GER)**

Seine besondere geometrische Form ist optimal zur Stoss- und Vibrationsdämpfung. Das Profil ist vor allem für den Schutz von Möbeln, Haushaltgeräten, elektrischen und elektronischen Geräten geeignet.

**(FRA)**

Ce profil trouve son utilisation idéale dans la protection des meubles, l'électroménager, les appareils électriques et électroniques. Sa forme géométrique particulière est optimale pour l'absorption des chocs et des vibrations.

**(ESP)**

Su especial forma geométrica es óptima en la absorción de los golpes y de las vibraciones. Encuentra su utilización ideal en la protección de muebles, electrodoméstico, equipos eléctricos y electrónicos.

## PROFILO "VETRO"

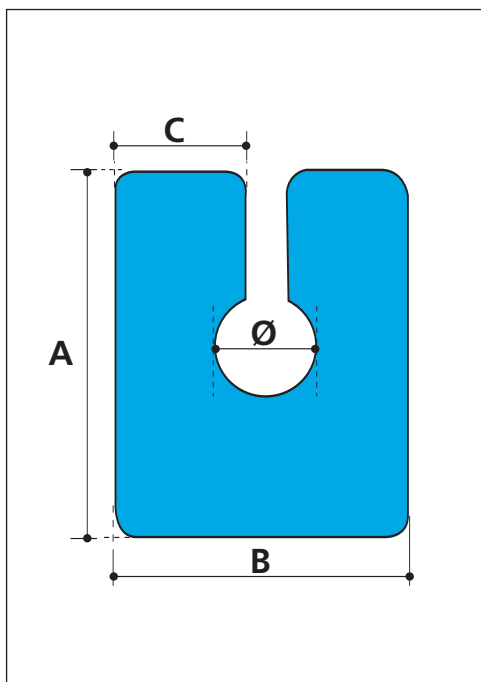
Larghezza standard	mm	Colore	Azzurro	Densità	Kg/m <sup>3</sup>	Dimensione cartone	mm
Standard length Standardlänge Longuer standard Largo estándar	2000	Colour Couleur Farbe Color	Blue Blau Bleu Azul	Density Dichte Densité Densidad	28/32	Carton size Kartongröße Dimension du carton Dimensión cartón	2100x600x450

Codice	Descrizione	A	B	C	Ø	x Cartone
077 PRV ridotto BN	Profilo "Vetro" ridotto	34 mm ± 2	20 mm ± 2	9 mm ± 1	5 mm ± 1	700 mt
077 PRV 2535 MBN	Profilo "Vetro" 25x35 foro grande	34 mm ± 2	25 mm ± 2	12 mm ± 1	14 mm ± 2	440 mt
077 PRV 2535 BN	Profilo "Vetro" 25x35	34 mm ± 2	25 mm ± 2	12 mm ± 1	6 mm ± 1	520 mt
077 PRV 3045 BN	Profilo "Vetro" 30x45	45 mm ± 2	30 mm ± 2	14 mm ± 1	10 mm ± 2	360 mt

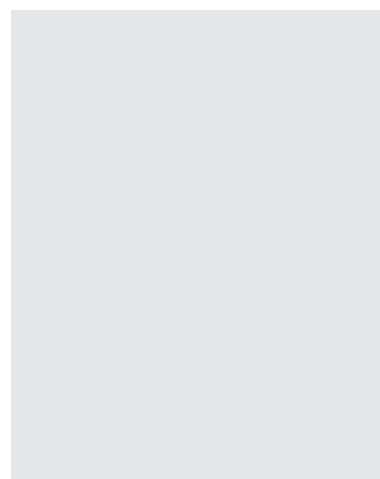
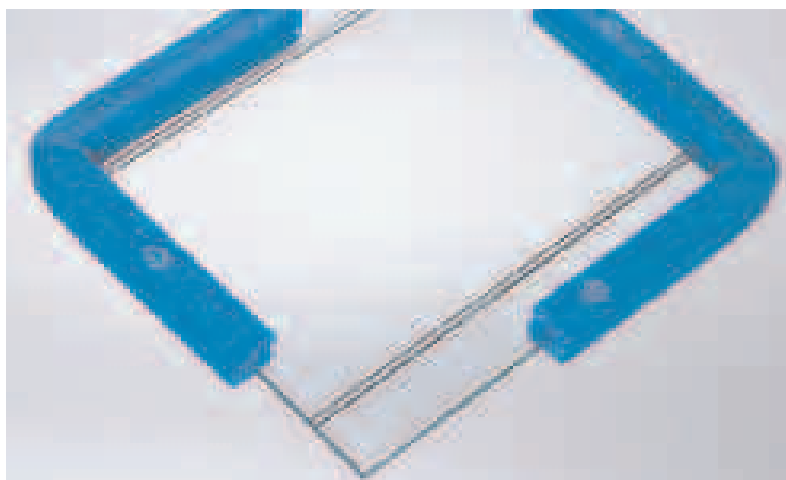

**Applicazioni**

*Fields of application  
Verwendungsbereiche  
Utilisations  
Aplicaciones*

**(ITA)**

**È una protezione ideale per vetri, specchi, cristalli e vetri per auto.**

**(ING)**

It is an ideal protection for glasses, mirrors, crystals and car's windows.

**(GER)**

Ein idealer Schutz für Glasteile, Spiegel, Kristallglaselemente und Autoscheiben.

**(FRA)**

Ce profil est une protection idéale pour les vitres, miroirs, cristaux et parebrise de voitures.

**(ESP)**

Es una protección ideal para vidrios, espejos, cristales y vidrios de autos.

**A richiesta**

*On request  
Auf anfrage  
Sous demande  
A pedido*

**(ITA)**

**Disponibile in bobine da 800 mt. e 350 mt.**

**(ING)**

Available in rolls of 800 mt. e 350 mt.

**(GER)**

Erhältlich in rollen von 800 M und 350 M

**(FRA)**

Disponible en couronniers de 800 mt. e 350 mt.

**(ESP)**

Disponible en bobinas de 800 m. y 350 m.

## PROFILO "PIATTO"

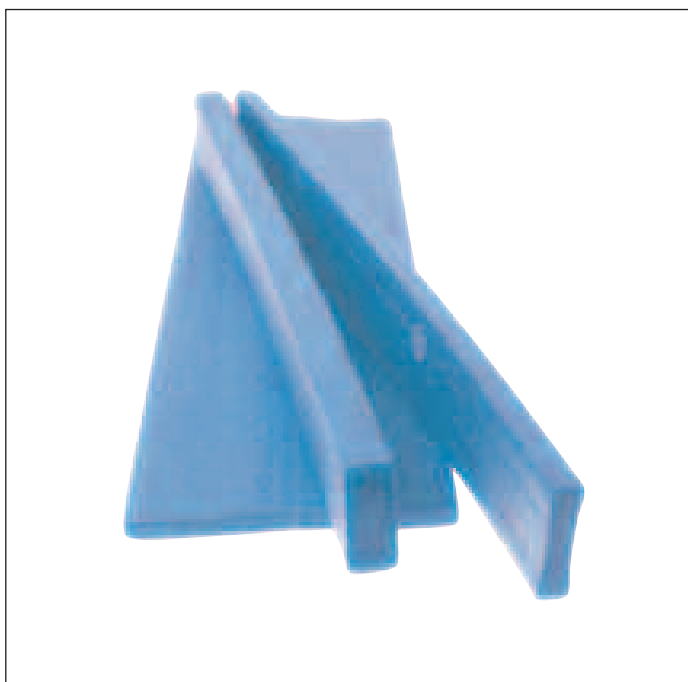
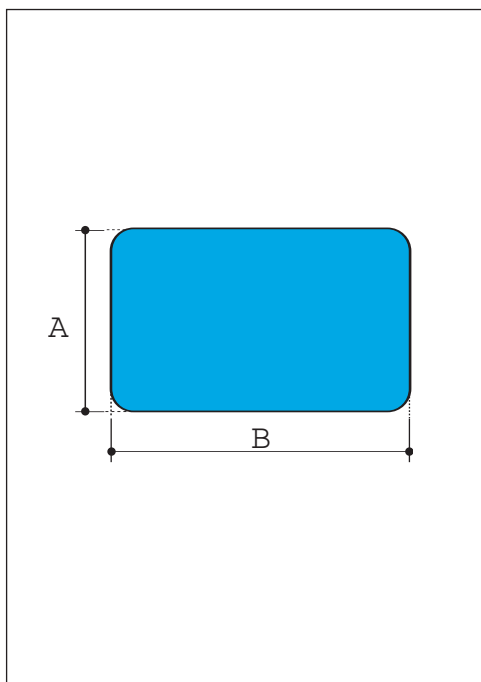
Larghezza standard	mm	Colore	Azzurro	Densità	Kg/m <sup>3</sup>	Dimensione cartone	mm
Standard length Standardlänge Longuer standard Largo estándar	2000	Colour Couleur Farbe Color	Blue Blau Bleu Azul	Density Dichte Densité Densidad	28/32	Carton size Kartongröße Dimension du carton Dimensión cartón	2100x600x450

Codice	Descrizione	A	B	x Cartone			
077 PRP 1050 BN	Profilo "Piatto" 50 sp. 10 mm	10 mm ± 2	50 mm ± 2	660 mt			
077 PRP 2050 BN	Profilo "Piatto" 50 sp. 20 mm	20 mm ± 2	50 mm ± 2	480 mt			
077 PRP 6525 BN	Profilo "Piatto" 65 sp. 25 mm	25 mm ± 2	65 mm ± 2	308 mt			
077 PRP 10140 BN	Profilo "Piatto" 130/150 sp. 10 mm	10 mm ± 2	140 mm ± 10	300 mt			
077 PRQ 5050 BN	Profilo "Quadro" 50x50	50 mm ± 3	50 mm ± 3	176 mt			
077 PRR 50100 BN	Profilo " Rettangolare" 50x100	50 mm ± 3	100 mm ± 3	96 mt			

PROFILO "PIATTO"

**sistem  
pack**

DENSITA' 28/32

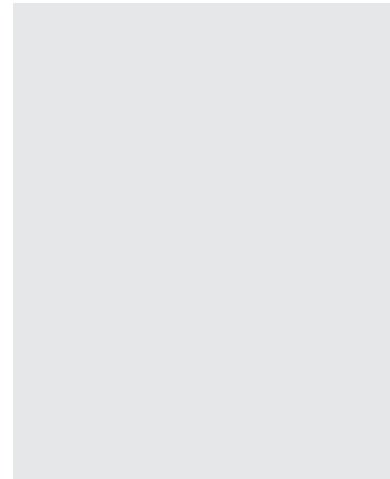
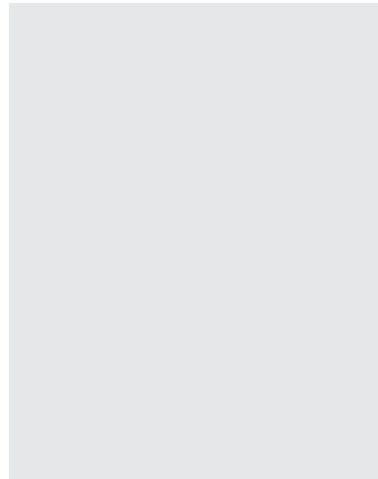

## CILINDRO "PIENO"

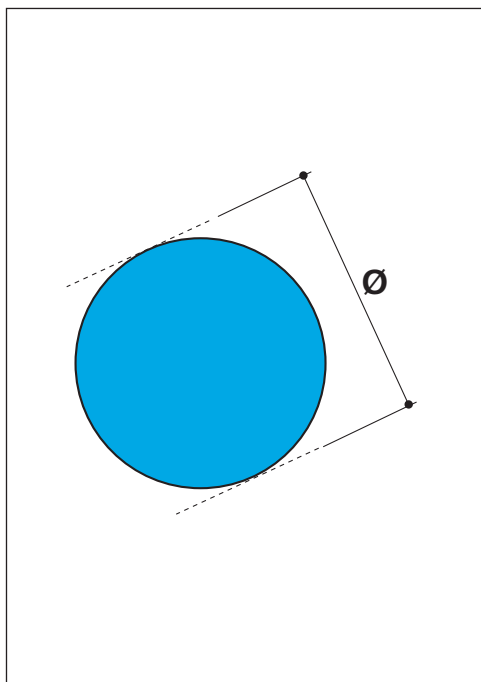
Larghezza standard	mm	Colore	Azzurro	Densità	Kg/m <sup>3</sup>	Dimensione cartone	mm
Standard length Standardlänge Longuer standard Largo estándar	2000	Colour Couleur Farbe Color	Blue Blau Bleu Azul	Density Dichte Densité Densidad	28/32	Carton size Kartongröße Dimension du carton Dimensión cartón	2100x600x450

Codice	Descrizione	Ø	x Cartone				
077 TP 05000 BN	Cilindro pieno ø 50 mm	50 mm ± 3	200 mt				
077 TP 07500 BN	Cilindro pieno ø 75 mm	70 mm ± 3	96 mt				
077 TP 10000 BN	Cilindro pieno ø 100 mm	100 mm ± 3	56 mt				
077 TP 13000 BN	Cilindro pieno ø 130 mm	130 mm ± 4	32 mt				
077 TP 15000 BN	Cilindro pieno ø 150 mm	150 mm ± 4	24 mt				

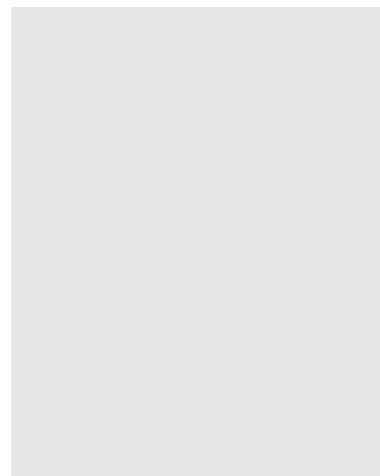
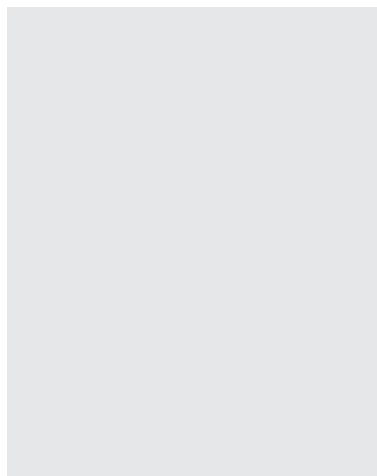
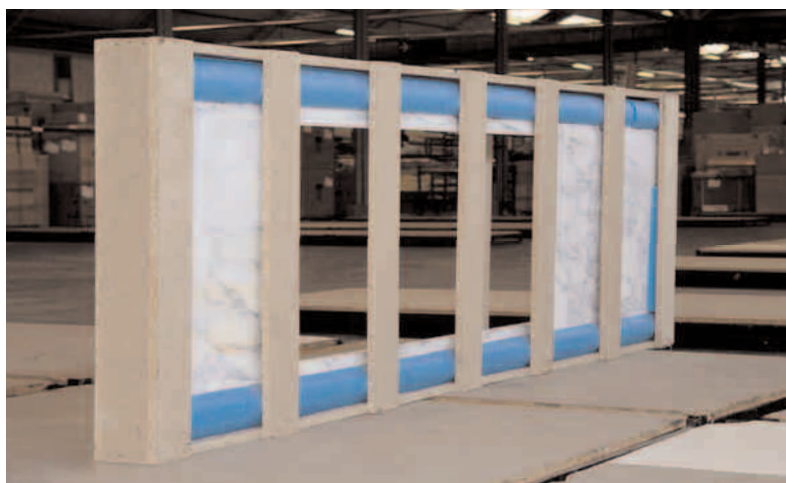

**Applicazioni**

*Fields of application  
Verwendungsbereiche  
Utilisations  
Aplicaciones*

**(ITA)**

**Studiato per proteggere i bordi, si monta facilmente e si regge da solo. Ideale per ripiani, tops, tavoli, marmi, ecc...**

**(ING)**

Particularly studied to protect edges, easily to fit and standing by itself. Ideal for tops, tables, shelves, ecc...

**(GER)**

Insbesondere für den Kantenschutz geplant, ist das Aufmontieren äußerst einfach und die Profile halten von selbst. Ideal für Ablagen, Tops, Tische, Marmorartikel, usw...

**(FRA)**

Profil spécialement conçu pour la protection des bords, il peut facilement être employé pour les meubles de bureaux.

**(ESP)**

Estudiado para proteger los bordes, se monta fácilmente y se sostiene solo, ideal para estantes, encimeros, tableros de mesas, mármoles, etc.

## ANGOLARE "3 VIE"

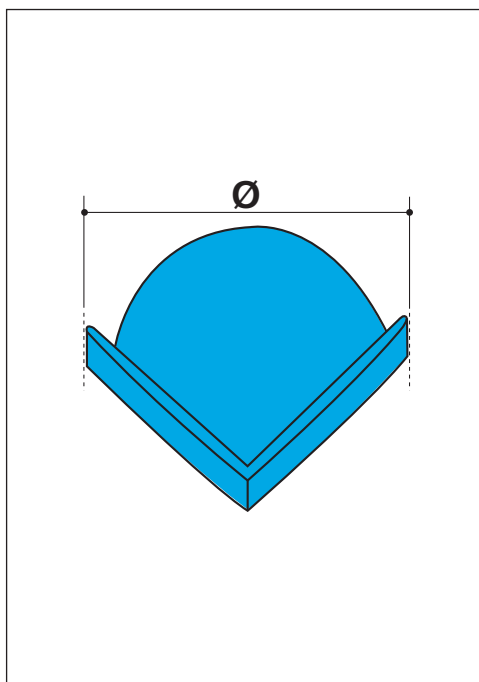
Colore	Azzurro	Densità	Kg/m <sup>3</sup>	Dimensione cartone	mm	
Colour	Blue	Density	28/32	Carton size	1100x600x450	
Couleur	Blau	Dichte		Kartongröße		
Farbe	Bleu	Densité		Dimension du carton		
Color	Azul	Densidad		Dimensión cartón		

Codice	Descrizione	Ø	Sp	x Cartone			
077 AN 07010 BN	Angolare ø 70 sp. 10 mm	70 mm ± 3	10 mm ± 0,5	3180 pz			
077 AN 10008 BN	Angolare ø 100 sp. 8 mm	100 mm ± 3	8 mm ± 0,5	2100 pz			
077 AN 10010 BN	Angolare ø 100 sp. 10 mm	100 mm ± 3	10 mm ± 0,5	1680 pz			
077 AN 10012 BN	Angolare ø 100 sp. 12 mm	100 mm ± 3	12 mm ± 0,5	1344 pz			
077 AN 10020 BN	Angolare ø 100 sp. 20 mm	100 mm ± 3	20 mm ± 0,5	840 pz			
077 AN 13010 BN	Angolare ø 130 sp. 10 mm	130 mm ± 4	10 mm ± 0,5	960 pz			
077 AN 13012 BN	Angolare ø 130 sp. 12 mm	130 mm ± 4	12 mm ± 0,5	768 pz			
077 AN 13020 BN	Angolare ø 130 sp. 20 mm	130 mm ± 4	20 mm ± 0,5	480 pz			
077 AN 15010 BN	Angolare ø 150 sp. 10 mm	150 mm ± 4	10 mm ± 0,5	660 pz			
077 AN 15020 BN	Angolare ø 150 sp. 20 mm	150 mm ± 4	20 mm ± 0,5	330 pz			

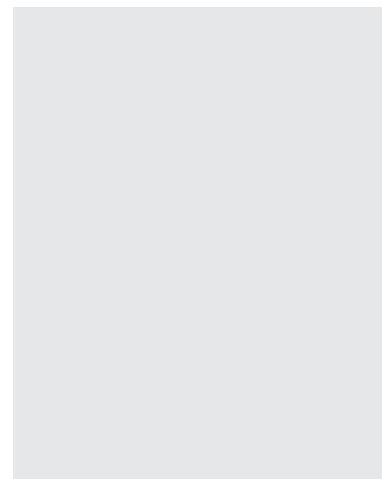
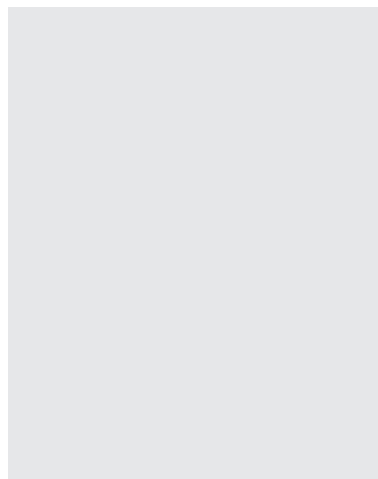
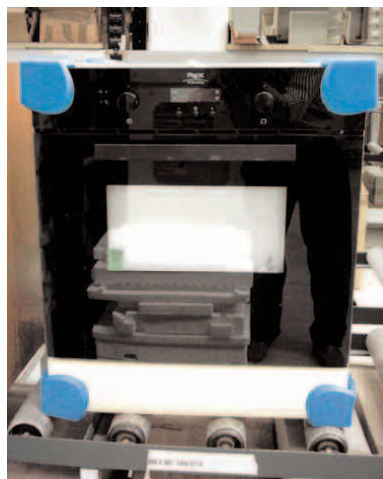

**Applicazioni**

*Fields of application  
Verwendungsbereiche  
Utilisations  
Aplicaciones*

**(ITA)**

**A protezione di tutti i tipi di angoli, sono ampiamente usati nel settore del mobile, dell'elettronica, degli elettrodomestici, dell'oggettistica e dell'arredo bagno.**

**(ING)**

To protect all kinds of edges, are widely used in the furniture, electronics, domestic appliances, objectistic and bathroom furniture fields.

**(GER)**

Als Schutz aller Art von Ecken werden die Profile zahlreich in der Möbelbranche, im Elektronikbereich, bei Haushaltgeräten, bei Zier und Schmuckgegenständen sowie für Badzimmereinrichtungen verwendet.

**(FRA)**

Protection de tous les types de coins qui sont largement utilisés dans le secteur du mobilier, pour les appareils électroniques et électroménagers, objets et dans l'ameublement des salles de bain.

**(ESP)**

Como protección de todo tipo de esquinas, se usan ampliamente en el sector del mueble, de la electrónica, de los electrodomésticos, de los accesorios y de la decoración del baño.

## ANGOLARI "4 VIE"

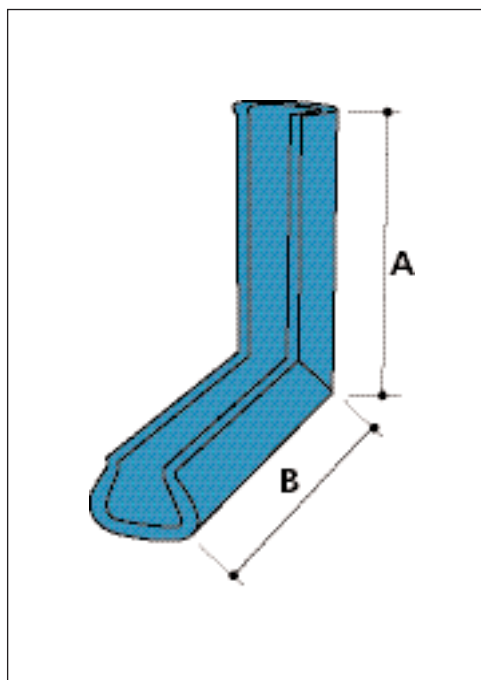
Colore	Azzurro	Densità	Kg/m <sup>3</sup>	Imballo in sacco	Volume	
Colour	Blue	Density	28/32	Sac	0,7m <sup>3</sup>	
Couleur	Blau	Dichte				
Farbe	Bleu	Densité				
Color	Azul	Densidad				

Codice	Descrizione	A	B	x Sacco			
077 AU 1010 0515	Angolo 10x10 profilo "U" 05 - 15	100 mm ± 3	100 mm ± 3	1890 pz			
077 AU 1010 1020 D	Angolo 10x10 profilo "U" 10 - 20	100 mm ± 3	100 mm ± 3	1540 pz			
077 AU 1010 1525 B	Angolo 10x10 profilo "U" 15 - 25	100 mm ± 3	100 mm ± 3	1400 pz			
077 AU 1010 2035 B	Angolo 10x10 profilo "U" 20 - 35	100 mm ± 3	100 mm ± 3	1000 pz			
077 AU 1515 2035	Angolo 15x15 profilo "U" 20 - 35	140 mm ± 3	140 mm ± 3	520 pz			
077 AU 1010 3045	Angolo 10x10 profilo "U" 30 - 45	100 mm ± 3	100 mm ± 3	850 pz			
077 AU 1010 3040	Angolo 10x10 profilo "U" 30 - 40 sp.20	100 m ± 3	100 mm ± 3	680 pz			
077 AU 1010 4565 D	Angolo 10x10 profilo "U" 45 - 65	100 mm ± 3	100 mm ± 3	564 pz			
077 AU 1515 4565 D	Angolo 15x15 profilo "U" 45 - 65	150 m ± 3	150 m ± 3	420 pz			
077 AU 1010 4060 M	Angolo 10x10 profilo "U" 40 - 60 sp.20	100 m ± 3	100 m ± 3	480 pz			
077 AU 1010 6085	Angolo 10x10 profilo "U" 60 - 85	100 m ± 3	100 m ± 3	400 pz			
077 AU 1010 80100	Angolo 10x10 profilo "U" 80 - 100	100 m ± 3	100 m ± 3	144 pz			
077 AU 2020 72120	Angolo 20x20 profilo "U" 72 - 120	200 mm ± 3	200 mm ± 3	144 pz			
077 AV 1010 2535	Angolo 10x10 profilo "V" 25 - 35	100 mm ± 3	100 mm ± 3	2000 pz			

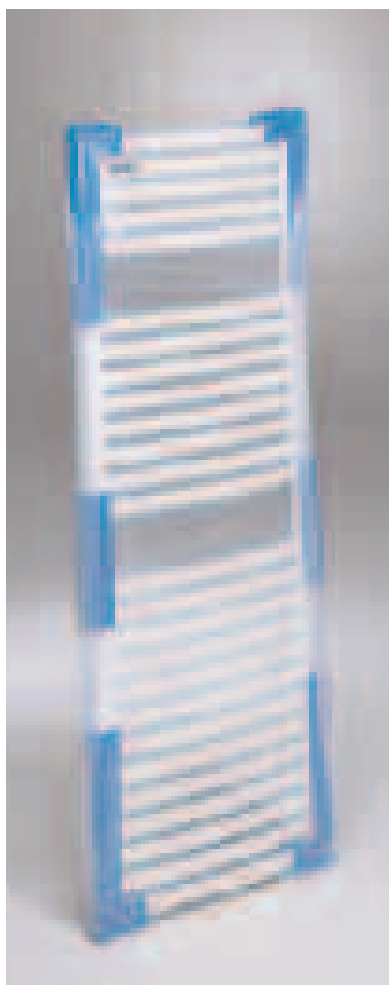

**Applicazioni**

*Fields of application*  
*Verwendungsbereiche*  
*Utilisations*  
*Aplicaciones*

**(ITA)**

**Viene utilizzato nella protezione degli spigoli.**

**(ING)**

It is suitable to protect edges.

**(GER)**

Kommt für den Schutz der Ecken zur Anwendung.

**(FRA)**

Ce profil est utilisé pour la protection des coins.

**(ESP)**

Se utiliza en la protección de aristas.

## TUBOLARE

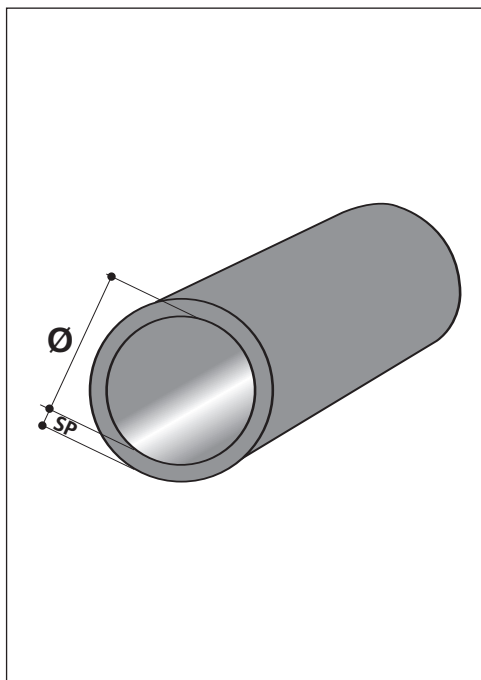
Larghezza standard	mm	Colore	Grigio	Densità	Kg/m <sup>3</sup>	Dimensione cartone	mm
Standard length Standardlänge Longuer standard Largo estándar	2000	Colour Couleur Farbe Color	Grey Grau Gris Gris	Density Dichte Densité Densidad	30/35	Carton size Kartongröße Dimension du carton Dimensión cartón	2100x600x450

Codice	Ø int.	Sp	x Cartone			
01106010N 6-10	min. 11 mm	max. 12 mm	6 mm ± 1	864 mt		
01106012N 6-12	min. 13 mm	max. 14 mm	6 mm ± 1	730 mt		
01106014N 6-14	min. 15 mm	max. 16 mm	6 mm ± 1	660 mt		
01106016N 6-15-16	min. 17 mm	max. 18 mm	6 mm ± 1	570 mt		
01106018N 6-18	min. 19 mm	max. 20 mm	6 mm ± 1	480 mt		
01106020N 6-20	min. 21,5 mm	max. 23 mm	6 mm ± 1	450 mt		
01106022N 6-22	min. 23,5 mm	max. 25 mm	6 mm ± 1	390 mt		
01106025N 6-25	min. 26 mm	max. 27 mm	6 mm ± 1	320 mt		
01106027N 6-27-28	min. 29 mm	max. 31 mm	6 mm ± 1	280 mt		
01106034N 6-34-35	min. 35,5 mm	max. 37 mm	6 mm ± 1	220 mt		
01106042N 6-42	min. 45 mm	max. 47 mm	6 mm ± 1	180 mt		